

# MS6015 / MS7025 / MS9025

MS TURNING SERIES – PVD COATED GRADES  
FOR HIGH PRECISION AND SMALL PARTS MACHINING



# MS6015 / MS7025 / MS9025

## TRANSFORMATION OF MACHINING ON SWISS TYPE AUTOMATIC LATHES



The first parts to be machined on Swiss type automatic lathes were watch components. The use soon expanded to machining electrical parts for home appliances, printers as well as automobile component applications such as sensors and electrification technology parts. The high precision capability of Swiss type lathes has also lent itself to the machining of parts essential to daily life. These parts include robotic and medical implants as well as simple but essential parts for water taps. Expanding the type of workpieces is not the only modern advancement, even higher precision, productivity and quality has become necessary.

### **DUE TO CHANGES IN MATERIALS AND COMPONENT GEOMETRIES, VARIOUS PROBLEMS HAVE ARISEN THAT NEED SOLUTIONS:**

- Complex workpiece shapes
- Ever more difficult-to-cut materials
- Tighter dimensional tolerances



### **MITSUBISHI MATERIALS IS COMMITTED TO PRODUCT DEVELOPMENT AND THE COMMERCIALISATION OF NEW TOOLS THAT HAVE THE CUTTING CAPABILITY AND MACHINE TOOL ADAPTABILITY THAT CUSTOMERS DESIRE AS FOLLOWS:**

- Development of new coating adapted to workpiece materials and machining methods
- Optimisation of welding, wear and fracture resistance
- High precision machining enabled by the development of high quality cutting edge geometries

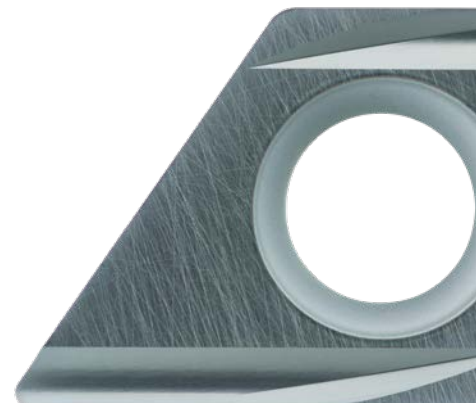

# MS7025

## DRAMATICALLY IMPROVED WELDING AND WEAR RESISTANCE IN LOW FEED MACHINING ENABLED BY A MORE PRECISE NANO-MULTILAYER COATING

### NANO-MULTILAYER COATING

By combining the high lubrication layer with excellent welding resistance, and the high hardness layer with a greater wear resistance that suppresses the progress of wear at the nano-level, the film damage is significantly reduced and the welding and wear resistance are dramatically improved.

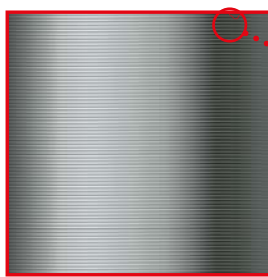

Nano-multilayer coating

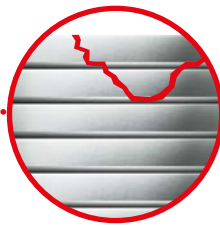

Enlarged image

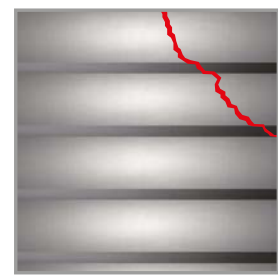

Conventional multilayer coating

### EFFECTS OF THE HIGH LUBRICATION LAYER

The nano-level, high lubrication layer suppresses built-up edge caused by chip welding which tends to occur in low feed machining and in addition reduces blemishes on the machined surface.

#### Surface finish

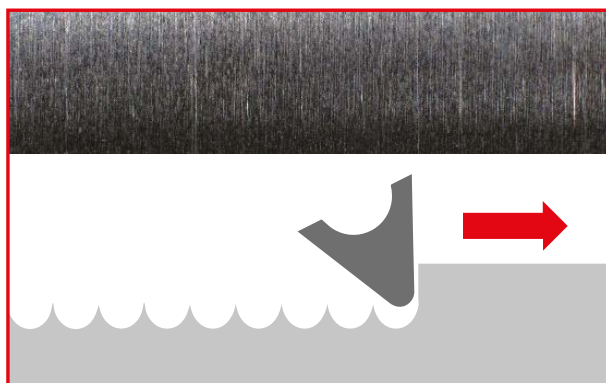

MS7025

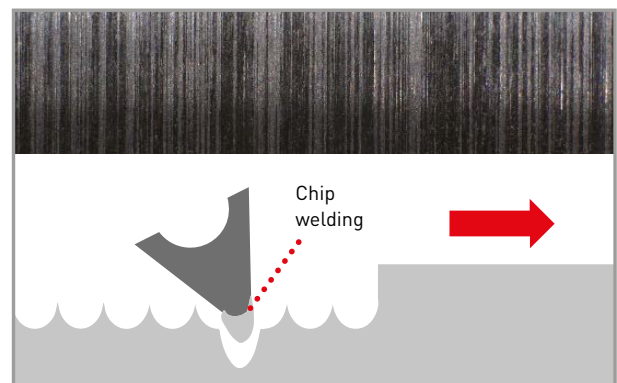

Conventional



# MS7025

## CUTTING PERFORMANCE

### COMPARISON OF END FACE MACHINED SURFACES USING 3D ANALYSIS

Achieves stable machining even during end face machining where the cutting speed is liable to change.

Workpiece material: C45

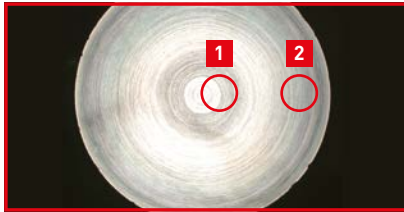

MS7025

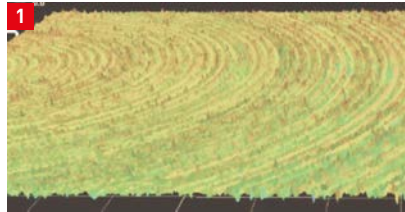

Good surface finish

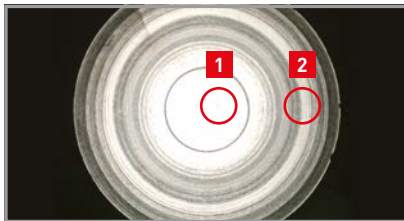

Conventional

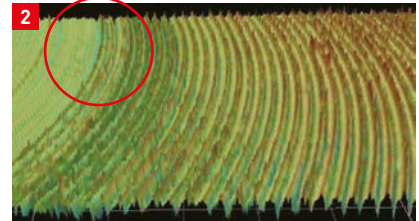
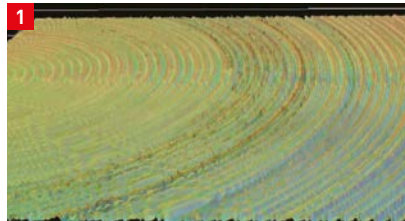

Changes in surface quality that cause machining marks

Workpiece material: X5CrNi18-10 ( 1.4301)

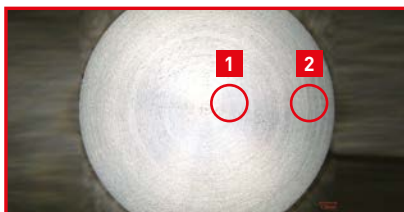

MS7025

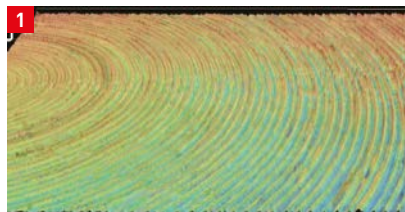

Good surface finish

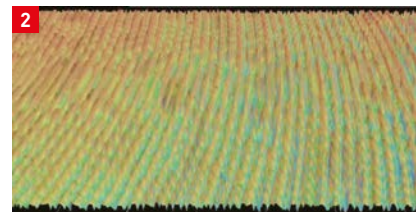

Conventional

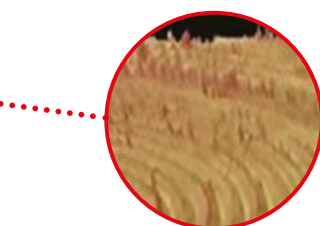
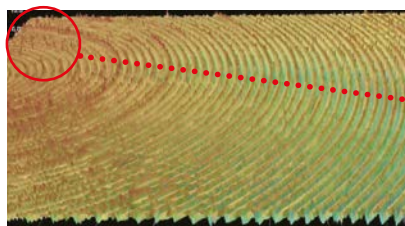

Roughness can occur in the low speed area (near the centre)

Workpiece material	Notation above
Insert	DCGT11T302
Vc max. (m/min)	100
f (mm/rev)	0.02
ap (mm)	0.2
Cutting mode	Wet cutting (Oil)

Image of facing  
Workpiece diameter  
16 mm

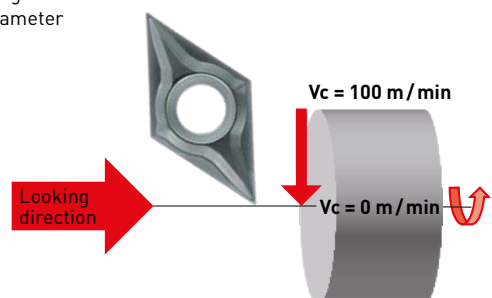



# MS7025

## CUTTING PERFORMANCE

### COMPARISON OF DIMENSIONAL CHANGE DURING LOW FEED MACHINING

When machining with MS7025 at low feed rate conditions, dimensional changes are reduced and the quality of the machined surface is improved.

#### Workpiece Material: X105CrMo17 (DIN 1.4125)

Workpiece material	X105CrMo17 (DIN 1.4125)
Insert	DCGT11T301
Vc (m/min)	70
f (mm/rev)	0.02
ap (mm)	1.5
Cutting mode	Wet cutting (Oil)

#### Dimensional Change

The measured dimensional change is based on the first machined component

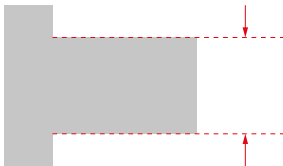

#### After machining 40 pieces



MS7025



Conventional A



Conventional B

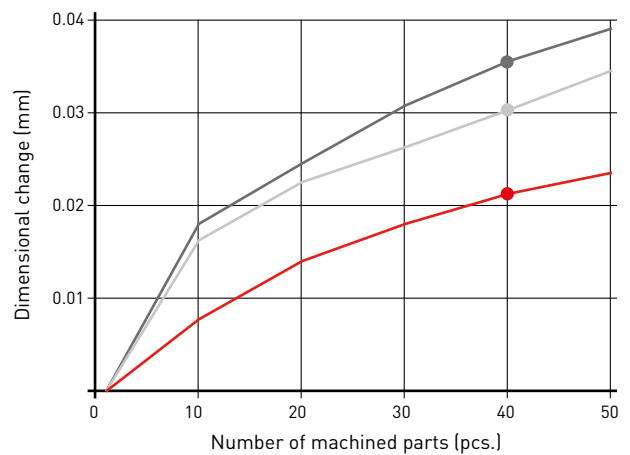

#### Workpiece Material: ELCH2S

Workpiece material	ELCH2S
Insert	DCGT11T302
Vc (m/min)	240
f (mm/rev)	0.03
ap (mm)	0.3
Cutting mode	Wet cutting (Oil)

#### After machining 500 pieces

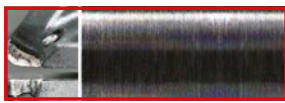

MS7025



Conventional A



Conventional B

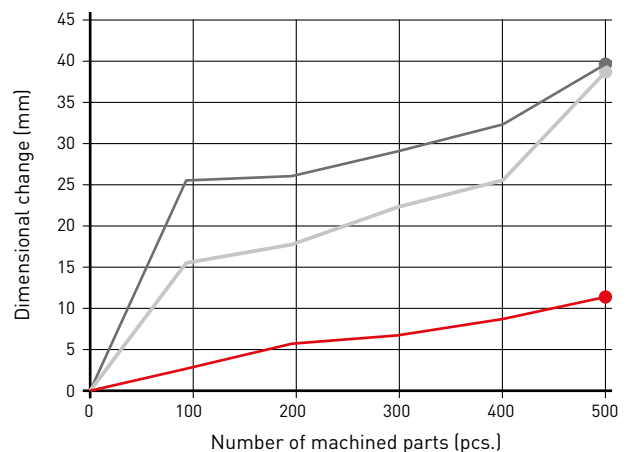

# MS9025

## EFFECTIVE REDUCTION OF NOTCH WEAR WITH A BALANCE OF WEAR AND FRACTURE RESISTANCE

### IMPROVED CEMENTED CARBIDE

Thermal conductivity has been improved by optimising the grain size and therefore reducing the boundary contact between the WC particles. This optimisation reduces the temperature of the cutting edge during machining.

#### MS9025

Reducing the cutting edge temperature by improved thermal conductivity.

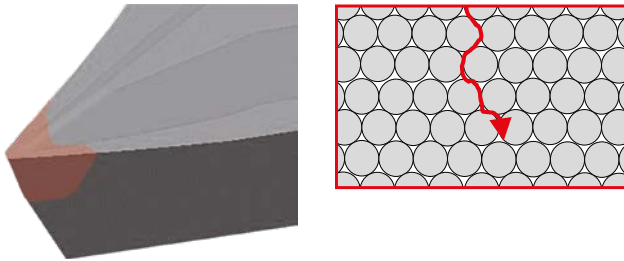

#### Conventional

Higher cutting edge temperatures due to more particle boundary contact.

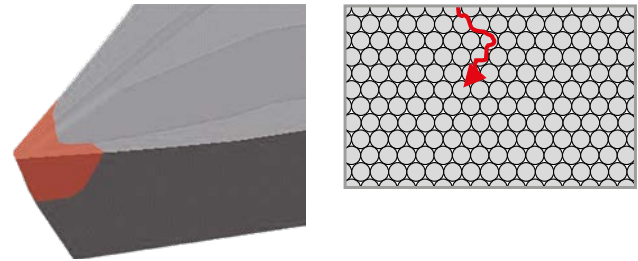

### SMOOTH SURFACE OF THE COATING

The even surface of the coating has been achieved by first making the carbide substrate smooth then by promoting straight growth of the coating crystals. This leads to excellent welding resistance.

#### Smooth Cemented Carbide

- Straight crystal growth
- Smooth carbide surface
- Excellent welding resistance

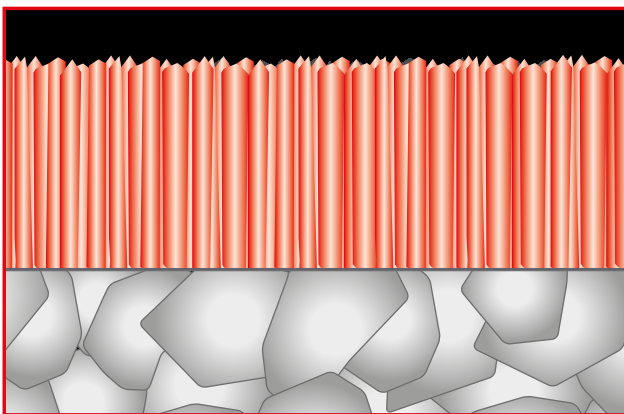

MS9025

#### Rough Cemented Carbide

- Random crystal growth direction
- Performance is variable due to defects and voids in the surface

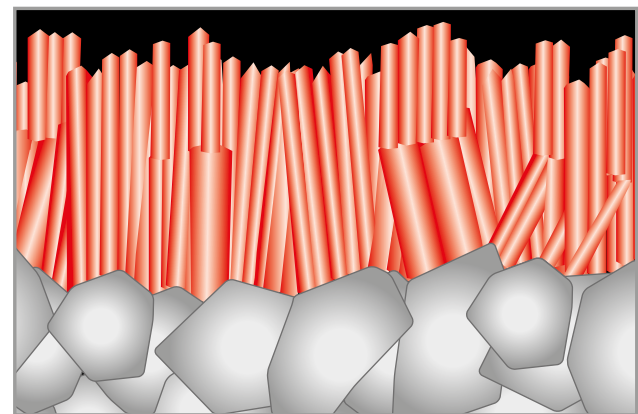

Conventional

# MS9025

## HIGH AL-RICH (AL,TI)N SINGLE LAYER COATING TECHNOLOGY



### Al-rich (Al,Ti)N

- Superior flank wear resistance
- Superior crater wear resistance
- Excellent welding resistance

### Special cemented carbide for MS9025

- Superior fracture resistance
- Excellent chipping resistance

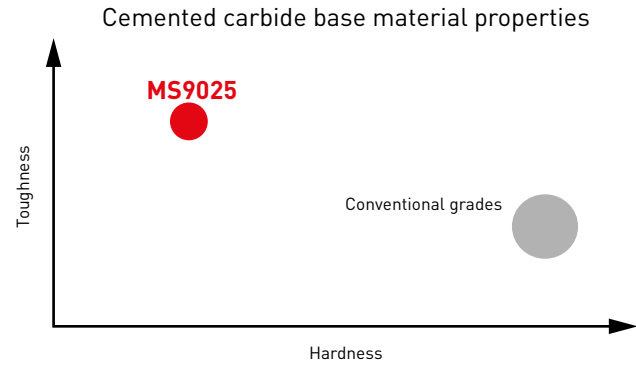

### HIGH AL AND CONVENTIONAL COATING COMPARISON

The high Al-rich (Al,Ti)N single layer coating provides stabilization of the high hardness phase and succeeds in dramatically improving wear, crater and welding resistance.

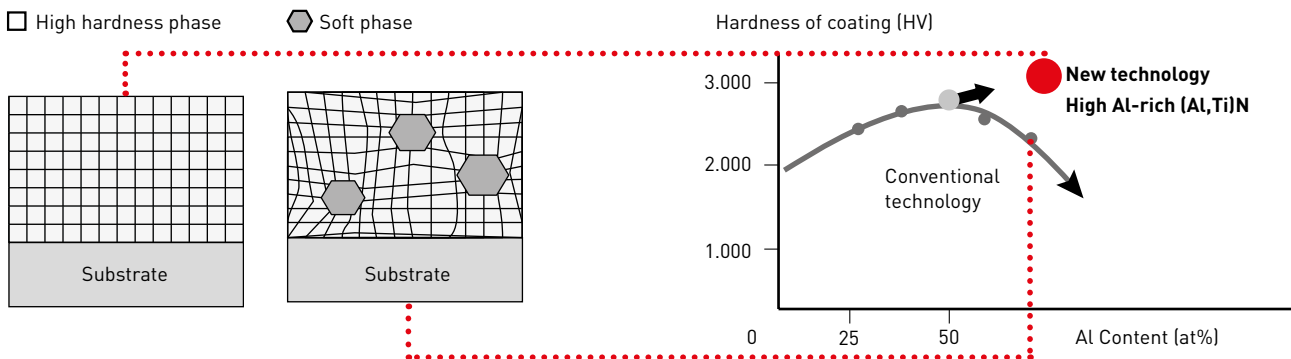

### STAINLESS STEEL DIN X5CRNI18-10 (1.4301), CUTTING EDGE COMPARISON

#### After machining 500 parts

Workpiece material	X5CrNi18-10 (DIN 1.4301)
Insert	DCGT11T302
Vc (m/min)	57
f (mm/rev)	0.03
ap (mm)	Rough: 0.05 Finish: 0.02
Cutting mode	External Continuous cutting Wet cutting (Oil)

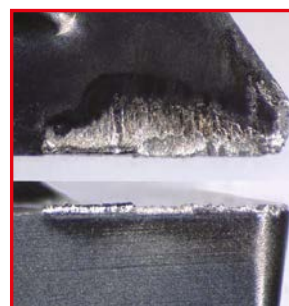

MS9025

VB = 0.03 mm



Conventional

VB = 0.07 mm



# MS6015

**IDEAL FOR TURNING PURE IRON, CARBON AND FREE CUTTING STEELS WHILST ALSO PROVIDING EXCELLENT DIMENSIONAL ACCURACY AND GOOD SURFACE FINISHES**

The unique combination of a special carbide substrate and a new PVD coating greatly improves wear resistance.

	<b>MS6015</b>	<b>Conventional</b>
Coating	TiCN Multi-layer	TiAlN
Hardness (HV)	3000	2800
Friction coefficient	Low	High
Base material hardness (HRA)	92.0	92.0
T.R.S (GPa)	2.0	2.0

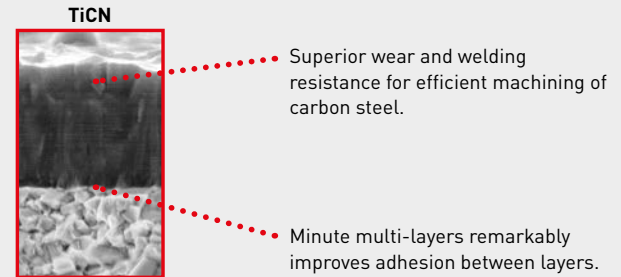

**Excellent chip discharge with a reduced coefficient of friction creates a stable surface finish.**

## OPTIMISING THE LAMINATED STRUCTURE

Optimising the laminated structure enables the thickening of coating which leads to significant wear resistance.

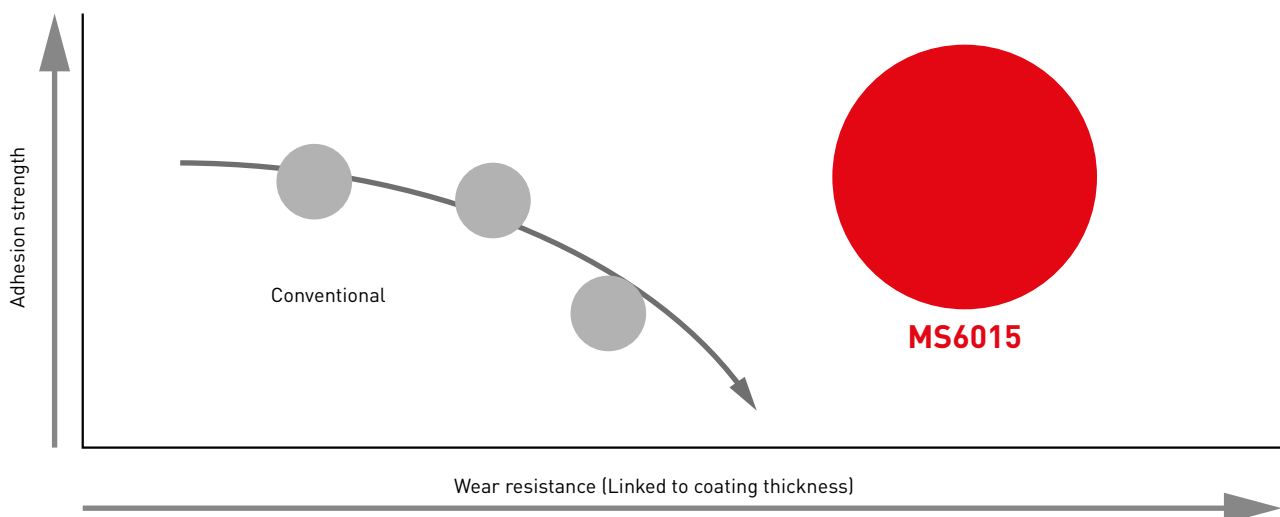

# MS6015 / MS7025 / MS9025

## APPLICATION RANGE

Material	Cutting mode	Grade	P	PVD
P Steel	Continuous cutting ↑ ↓ Interrupted cutting	<i>Low</i> <i>Medium</i> <i>High</i> MS6015 MS7025	P10	
			P20	MS6015
			P30	MS6015
			P40	MS7025
			P50	MS7025
Material	Cutting mode	Grade	M	PVD
M Stainless steel	Continuous cutting ↑ ↓ Interrupted cutting	<i>Low</i> <i>Medium</i> <i>High</i> MS7025 MS9025	M10	
			M20	MS7025
			M30	MS7025
			M40	MS9025
			M50	MS9025
Material	Cutting mode	Grade	S	PVD
S Titanium alloy (HRSA)	Continuous cutting ↑ ↓ Interrupted cutting	<i>Low</i> <i>Medium</i> <i>High</i> MS9025	S10	
			S20	
			S30	MS9025
			S40	MS9025
			S50	MS9025

### CORRECT AREA OF USE WHEN MACHINING STAINLESS STEEL

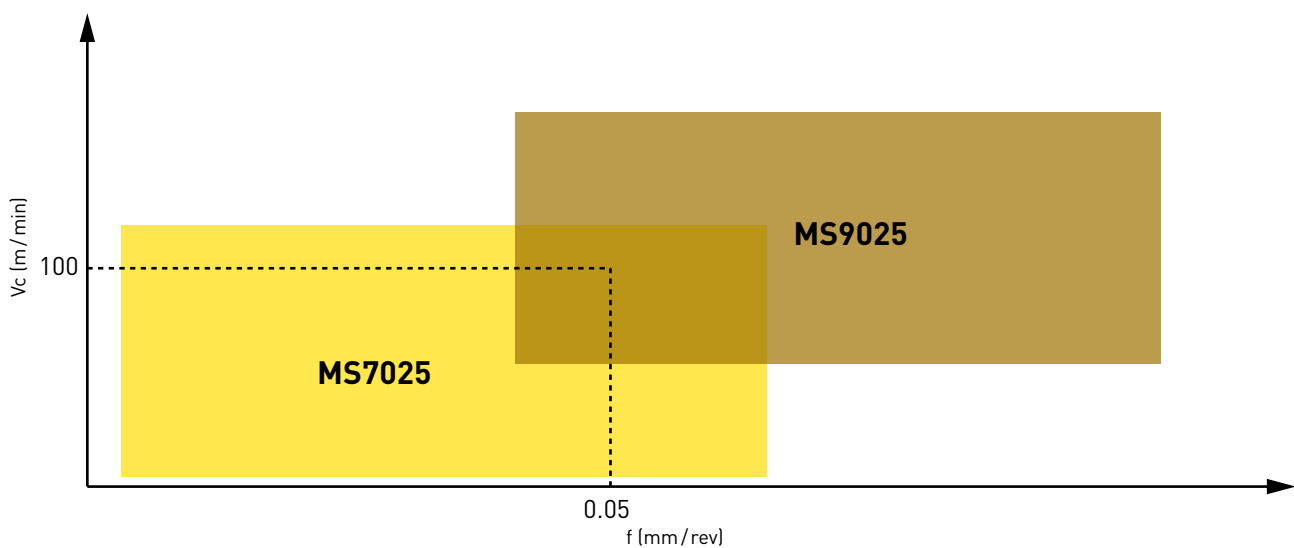

# MS6015 / MS7025 / MS9025

## IDEAL INSERTS FOR TURNING SMALL PARTS

Set the corner radius to a minus tolerance.

Order number	DCGT11T302 M R-SN		02M R 0.2 mm (R 0.15 – R 0.20 mm)
	DCGT11T304 M -SMG		04M R 0.4 mm (R 0.35 – R 0.40 mm)

### NEW BREAKER SYSTEM FOR FRONT TURNING

#### FS-P Breaker

For micro-low depth of cut

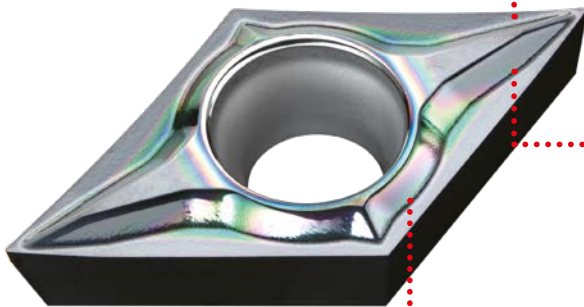

#### Curved cutting edge

The curved cutting edge reduces cutting resistance and enables smooth chip evacuation. It also enables good initial entry to the workpiece and resists vibration and oscillation during machining.

#### High breaker wall

The high chipbreaker wall ensures that the chips separate properly and prevents the workpiece from being damaged when chips are discharged.

#### LS-P Breaker

For medium to high depth of cut

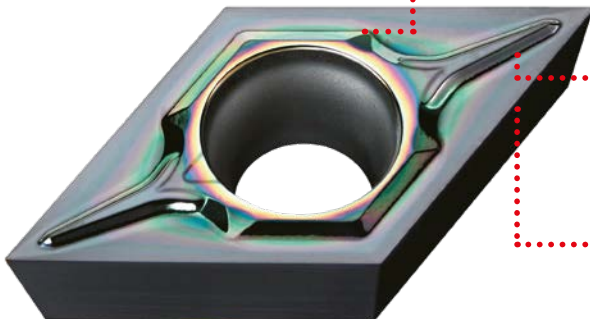

#### Polishing (Mirror-surface)

Welding resistance and chip evacuation are greatly improved.

#### Large pocket

The large pocket enhances chip evacuation during high depths of cut and suppresses chip clogging.

#### Parallel cutting edge

The parallel cutting edge greatly improves fracture resistance during high depths of cut.

### EXTREMELY HIGH QUALITY CUTTING EDGE

Technology that provides superior dimensional stability and reduces burrs.

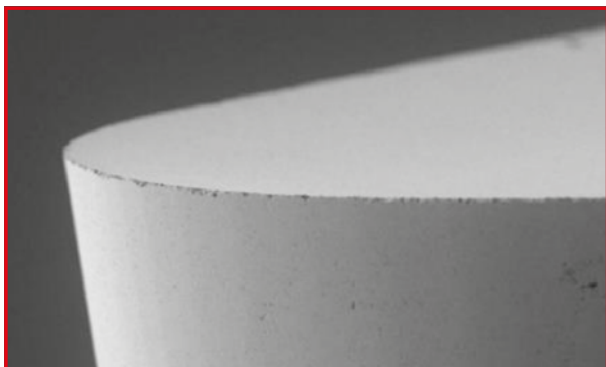

MS7025 / MS9025

Rz = 0.14  $\mu\text{m}$

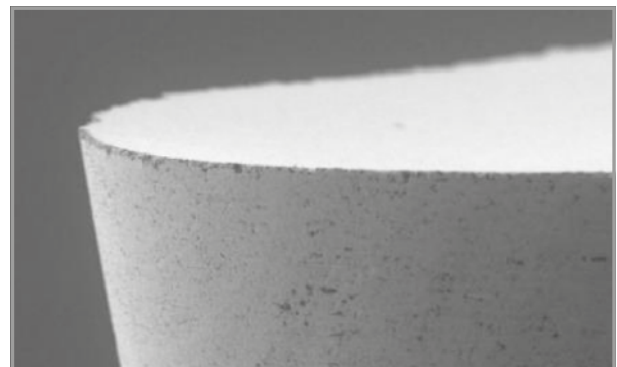

Conventional

Rz = 0.61  $\mu\text{m}$



# MS9025

## NEW TECHNOLOGY – CONTROLLED VIBRATION OF THE CUTTING TOOL

Using new machine technology to deliberately vibrate the tool in relation to the cutting direction is an effective way of breaking chips. This reduces production costs by reducing chip entanglement.

Without controlled vibration



With controlled vibration frequency = 0.75/rev



With controlled vibration frequency = 1.25/rev

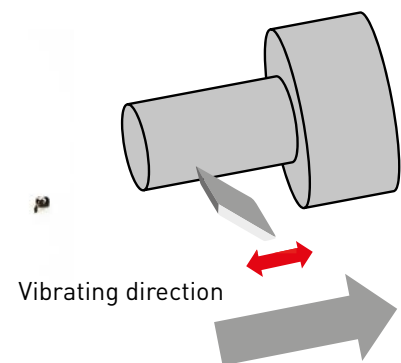

Challenges of controlled vibration machining:

Compared to standard machining there is a greater chance of chipping due to the extra stress on the cutting edge and also because of the consequences of work hardening.

### BENEFITS OF USING MS9025 FOR CONTROLLED VIBRATION MACHINING



1. Excellent fracture resistance due to the inherent toughness of the base material.
2. Effectively suppresses boundary wear damage during machining of difficult-to-cut materials. This is achieved by the optimised cemented carbide grain size that increases thermal conductivity and heating of the cutting edge.

#### After 500 passes at 15 m per pass

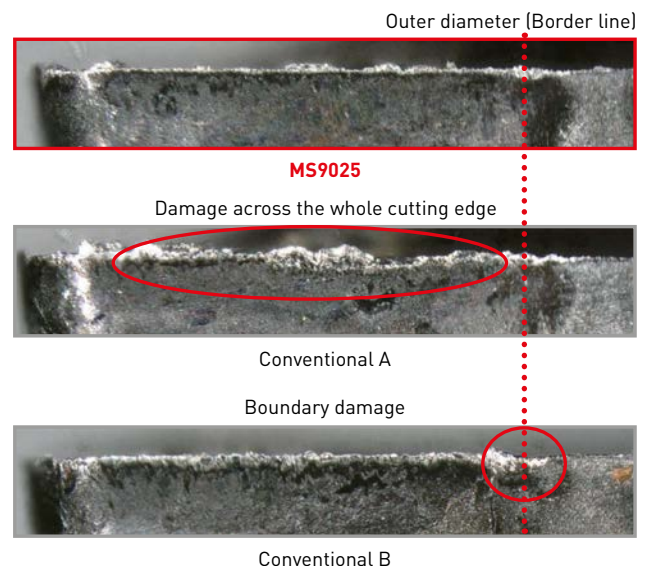



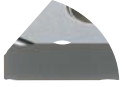
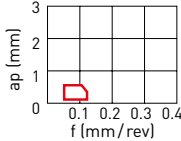





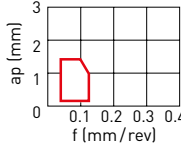
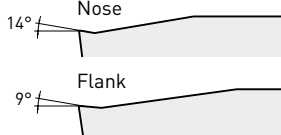
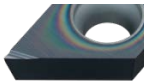
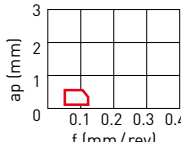

Workpiece material	DIN X5CrNi18-10 (1.4301)
Insert	DCGT11T302M
Vc (m/min)	100
f (mm/rev)	0.08
ap (mm)	1.0
The number of vibration	D = 1.25/rev
Cutting mode	External Continuous cutting Wet cutting (Oil)

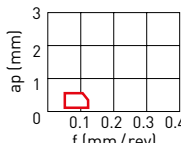

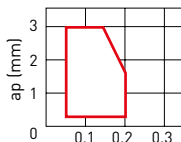
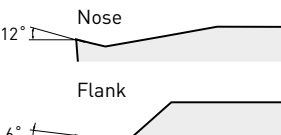
# BREAKER SYSTEM – NEGATIVE INSERTS

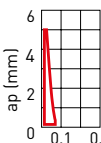
Tolerance		Features	Carbon steel / Alloy steel	Cross section geometry
<b>FINISH CUTTING</b>				
G	 R/L-FS	<b>PRECISION FINISHING</b> Double-sided chipbreaker. A narrow lead chipbreaker for good chip control. Sharp cutting edge gives a good surface finish.		

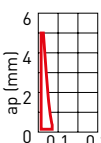
# BREAKER SYSTEM – POSITIVE INSERTS

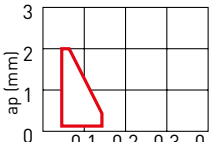
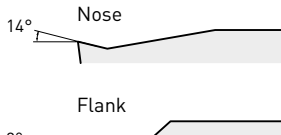
Tolerance		Features	Carbon steel / Alloy steel	Cross section geometry
<b>FINISH CUTTING</b>				
G	 FS-P	<b>FIRST RECOMMENDATION FOR FINISHING TITANIUM ALLOYS</b> Ideal for cobalt chromium alloy and copper alloy. The sharp edge produces a good surface finish. The curved edge allows smooth chip discharge. Lapping of the top surface gives a mirror finish for improved welding resistance.		
E	 R/L-SRF	<b>FINISHING</b> Lead chipbreaker controls chip flow. Sharp cutting edge gives a good surface finish.		
G	 R/L-F	<b>FINISH MACHINING ON AUTOMATIC LATHES</b> Lead chipbreaker controls chip flow. Sharp cutting edge gives a good surface finish.		
<b>LIGHT CUTTING</b>				
G	 LS-P	<b>LIGHT MACHINING ON AUTOMATIC LATHES</b> Designed with parallel cutting edges. Achieves stable chip control over a wide range, from low to medium depths of cut. Polished (mirror-surface) finish of insert surface drastically improves welding resistance and extends tool life.		
	 R/L-SS	<b>LIGHT MACHINING ON AUTOMATIC LATHES</b> Parallel chipbreaker geometry. Excellent chip control at low feed rates.		
<b>MEDIUM CUTTING</b>				
G	 R/L-SN	<b>MEDIUM CUTTING OF AUTOMATIC LATHE MACHINING</b> A parallel chipbreaker. Excellent chip control at low to medium feed rates.		
G	 SMG	<b>MEDIUM CUTTING</b> 3D moulded chipbreaker provides good chip control. G class insert provides a sharp cutting action, allowing high precision machining. Breaker geometry is suitable for copying and back turning.		

# TNGG

## NEGATIVE INSERTS (WITH HOLE)

P M S

G Class



R/L-FS

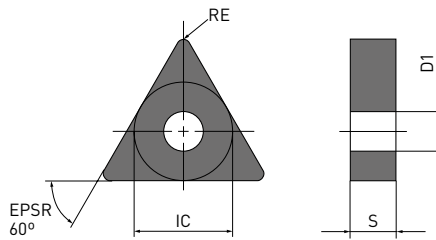

Order number		MS6015	MS7025	MS9025	IC	S	RE	D1
TNGG160402R-FS	F	●			9.525	4.76	0.2	3.81
TNGG160402L-FS	F	●			9.525	4.76	0.2	3.81
TNGG160404R-FS	F	●			9.525	4.76	0.4	3.81
TNGG160404L-FS	F	●			9.525	4.76	0.4	3.81
TNGG160408R-FS	F	●			9.525	4.76	0.8	3.81
TNGG160408L-FS	F	●			9.525	4.76	0.8	3.81

1/1

22



# VBGT

## 5° POSITIVE INSERTS (WITH HOLE)

**P** **M** **S**

**G Class**



FS-P

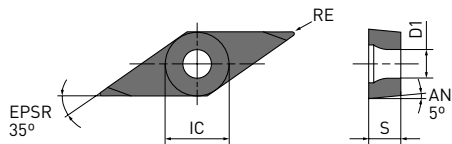

Order number		MS6015	MS7025	MS9025	IC	S	RE	D1
VBGT110301M-FS-P	F			●	6.35	3.18	0.1	2.9
VBGT110302M-FS-P	F			●	6.35	3.18	0.2	2.9
VBGT110304M-FS-P	F			●	6.35	3.18	0.4	2.9
VBGT160401M-FS-P	F			●	9.525	4.76	0.1	4.4
VBGT160402M-FS-P	F			●	9.525	4.76	0.2	4.4
VBGT160404M-FS-P	F			●	9.525	4.76	0.4	4.4
VBGT160408M-FS-P	F			●	9.525	4.76	0.8	4.4

1/1

22

# CCGH/CCET/CCGT

## 7° POSITIVE INSERTS (WITH HOLE)

P M S

E, G Class

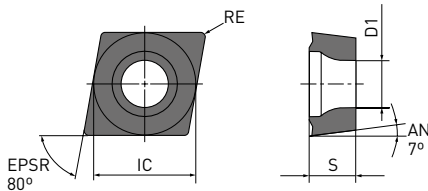
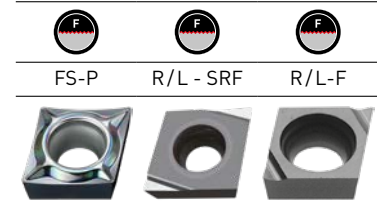

Order number		MS6015	MS7025	MS9025	IC	S	RE*2	D1
CCGT060201M-FS-P	F		●	●	6.35	2.38	0.1	2.8
CCGT060202M-FS-P	F		●	●	6.35	2.38	0.2	2.8
CCGT060204M-FS-P	F		●	●	6.35	2.38	0.4	2.8
CCGT09T301M-FS-P	F		●	●	9.525	3.97	0.1	4.4
CCGT09T302M-FS-P	F		●	●	9.525	3.97	0.2	4.4
CCGT09T304M-FS-P	F		●	●	9.525	3.97	0.4	4.4
<b>NEW</b> CCET060201MR-SRF	F			●	6.35	2.38	0.1	2.8
<b>NEW</b> CCET060201ML-SRF	F			●	6.35	2.38	0.1	2.8
<b>NEW</b> CCET060202MR-SRF	F			●	6.35	2.38	0.2	2.8
<b>NEW</b> CCET060202ML-SRF	F			●	6.35	2.38	0.2	2.8
<b>NEW</b> CCET060204MR-SRF	F			●	6.35	2.38	0.4	2.8
<b>NEW</b> CCET060204ML-SRF	F			●	6.35	2.38	0.4	2.8
<b>NEW</b> CCET09T301MR-SRF	F			●	9.525	3.97	0.1	4.4
<b>NEW</b> CCET09T301ML-SRF	F			●	9.525	3.97	0.1	4.4
<b>NEW</b> CCET09T302MR-SRF	F			●	9.525	3.97	0.2	4.4
<b>NEW</b> CCET09T302ML-SRF	F			●	9.525	3.97	0.2	4.4
<b>NEW</b> CCET09T304MR-SRF	F			●	9.525	3.97	0.4	4.4
<b>NEW</b> CCET09T304ML-SRF	F			●	9.525	3.97	0.4	4.4
CCGT03S101MR-F	F	●			3.57*1	1.39	0.1	2.0
CCGT03S101ML-F	F	●			3.57*1	1.39	0.1	2.0
CCGT03S102MR-F	F	●			3.57*1	1.39	0.2	2.0
CCGT03S102ML-F	F	●			3.57*1	1.39	0.2	2.0
CCGT03S104MR-F	F	●			3.57*1	1.39	0.4	2.0
CCGT03S104ML-F	F	●			3.57*1	1.39	0.4	2.0
CCGT04T001MR-F	F	●			4.37*1	1.79	0.1	2.4
CCGT04T001ML-F	F	●			4.37*1	1.79	0.1	2.4
CCGT04T002MR-F	F	●			4.37*1	1.79	0.2	2.4
CCGT04T002ML-F	F	●			4.37*1	1.79	0.2	2.4
CCGT04T004MR-F	F	●			4.37*1	1.79	0.4	2.4
CCGT04T004ML-F	F	●			4.37*1	1.79	0.4	2.4
CCGH060202MR-F	F	●			6.35	2.38	0.2	2.8
CCGH060202ML-F	F	●			6.35	2.38	0.2	2.8
CCGH060204MR-F	F	●			6.35	2.38	0.4	2.8
CCGH060204ML-F	F	●			6.35	2.38	0.4	2.8

1/1

\*1 Diameter of inscribed circle is non-ISO standard. (For SCLC type)

\*2 Nominal value (Max.)

● : Inventory maintained. ★ : Inventory maintained in Japan.

● = Expansion



# CCGT

## 7° POSITIVE INSERTS (WITH HOLE)

**P** **M** **S**

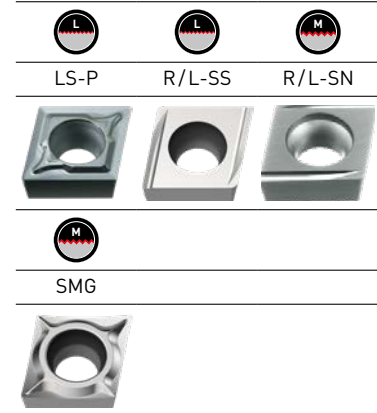
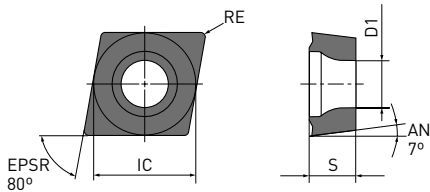
**G Class**



Order number	 	MS6015	MS7025	MS9025	IC	S	RE*	D1
CCGT0602V5M-LS-P	L			●	6.35	2.38	0.05	2.8
CCGT060201M-LS-P	L	●	●	●	6.35	2.38	0.1	2.8
CCGT060202M-LS-P	L	●	●	●	6.35	2.38	0.2	2.8
CCGT060204M-LS-P	L		●	●	6.35	2.38	0.4	2.8
CCGT09T301M-LS-P	L	●	●	●	9.525	3.97	0.1	4.4
CCGT09T302M-LS-P	L	●	●	●	9.525	3.97	0.2	4.4
CCGT09T304M-LS-P	L	●	●	●	9.525	3.97	0.4	4.4
CCGT060201MR-SS	L	●			6.35	2.38	0.1	2.8
CCGT060201ML-SS	L	●			6.35	2.38	0.1	2.8
CCGT060202MR-SS	L	●			6.35	2.38	0.2	2.8
CCGT060202ML-SS	L	●			6.35	2.38	0.2	2.8
CCGT09T301MR-SS	L	●			9.525	3.97	0.1	4.4
CCGT09T301ML-SS	L	●			9.525	3.97	0.1	4.4
CCGT09T302MR-SS	L	●			9.525	3.97	0.2	4.4
CCGT09T302ML-SS	L	●			9.525	3.97	0.2	4.4
CCGT09T304MR-SS	L	●			9.525	3.97	0.4	4.4
CCGT09T304ML-SS	L	●			9.525	3.97	0.4	4.4
CCGT060201MR-SN	M	●	●	●	6.35	2.38	0.1	2.8
CCGT060201ML-SN	M	●			6.35	2.38	0.1	2.8
CCGT060202MR-SN	M	●	●	●	6.35	2.38	0.2	2.8
CCGT060202ML-SN	M	●			6.35	2.38	0.2	2.8
CCGT09T301MR-SN	M	●	●	●	9.525	3.97	0.1	4.4
CCGT09T301ML-SN	M	●			9.525	3.97	0.1	4.4
CCGT09T302MR-SN	M	●	●	●	9.525	3.97	0.2	4.4
CCGT09T302ML-SN	M	●			9.525	3.97	0.2	4.4
CCGT09T304MR-SN	M	●	●	●	9.525	3.97	0.4	4.4
CCGT09T304ML-SN	M	●			9.525	3.97	0.4	4.4
CCGT060201M-SMG	M	●			6.35	2.38	0.1	2.8
CCGT060202M-SMG	M	●			6.35	2.38	0.2	2.8
CCGT060204M-SMG	M	●			6.35	2.38	0.4	2.8
CCGT09T301M-SMG	M	●			9.525	3.97	0.1	4.4
CCGT09T302M-SMG	M	●			9.525	3.97	0.2	4.4
CCGT09T304M-SMG	M	●			9.525	3.97	0.4	4.4

1/1

\* Nominal value (Max.)



# DCET / DCGT

## 7° POSITIVE INSERTS (WITH HOLE)

P M S

E, G Class

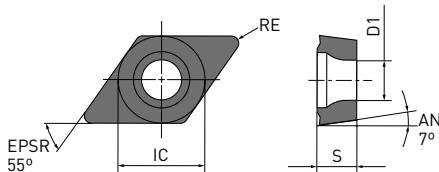
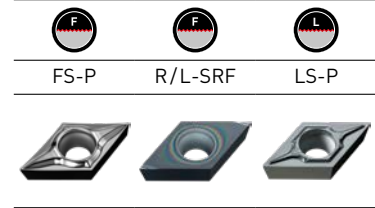

Order number			MS6015	MS7025	MS9025	IC	S	RE*	D1
DCGT070201M-FS-P	F			●	●	6.35	2.38	0.1	2.8
DCGT070202M-FS-P	F			●	●	6.35	2.38	0.2	2.8
DCGT070204M-FS-P	F			●	●	6.35	2.38	0.4	2.8
DCGT11T301M-FS-P	F			●	●	9.525	3.97	0.1	4.4
DCGT11T302M-FS-P	F			●	●	9.525	3.97	0.2	4.4
DCGT11T304M-FS-P	F			●	●	9.525	3.97	0.4	4.4
<b>NEW</b> DCET070201MR-SRF	F				●	6.35	2.38	0.1	2.8
<b>NEW</b> DCET070201ML-SRF	F				●	6.35	2.38	0.1	2.8
<b>NEW</b> DCET070202MR-SRF	F				●	6.35	2.38	0.2	2.8
<b>NEW</b> DCET070202ML-SRF	F				●	6.35	2.38	0.2	2.8
<b>NEW</b> DCET070204MR-SRF	F				●	6.35	2.38	0.4	2.8
<b>NEW</b> DCET070204ML-SRF	F				●	6.35	2.38	0.4	2.8
<b>NEW</b> DCET11T301ML-SRF	F				●	9.525	3.97	0.1	4.4
<b>NEW</b> DCET11T302ML-SRF	F				●	9.525	3.97	0.2	4.4
<b>NEW</b> DCET11T304ML-SRF	F				●	9.525	3.97	0.4	4.4
DCGT11T301MR-SRF	F			●	●	9.525	3.97	0.1	4.4
DCGT11T302MR-SRF	F			●	●	9.525	3.97	0.2	4.4
DCGT11T304MR-SRF	F			●	●	9.525	3.97	0.4	4.4
DCGT0702V5M-LS-P	L				●	6.35	2.38	0.05	2.8
DCGT070201M-LS-P	L		●	●	●	6.35	2.38	0.1	2.8
DCGT070202M-LS-P	L		●	●	●	6.35	2.38	0.2	2.8
DCGT070204M-LS-P	L		●	●	●	6.35	2.38	0.4	2.8
DCGT11T301M-LS-P	L		●	●	●	9.525	3.97	0.1	4.4
DCGT11T302M-LS-P	L		●	●	●	9.525	3.97	0.2	4.4
DCGT11T304M-LS-P	L		●	●	●	9.525	3.97	0.4	4.4

1/2

\* Nominal value (Max.)



## DCGT - 7° POSITIVE INSERTS (WITH HOLE)



G Class



R/L-SS

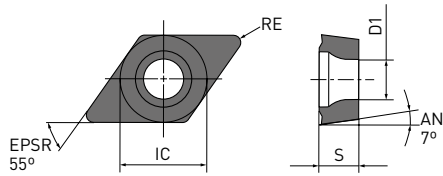

Order number		MS6015	MS7025	MS9025	IC	S	RE*	D1
DCGT070201MR-SS	L	●			6.35	2.38	0.1	2.8
DCGT070201ML-SS	L	●			6.35	2.38	0.1	2.8
DCGT070202MR-SS	L	●			6.35	2.38	0.2	2.8
DCGT070202ML-SS	L	●			6.35	2.38	0.2	2.8
DCGT11T301MR-SS	L	●			9.525	3.97	0.1	4.4
DCGT11T301ML-SS	L	●			9.525	3.97	0.1	4.4
DCGT11T302MR-SS	L	●			9.525	3.97	0.2	4.4
DCGT11T302ML-SS	L	●			9.525	3.97	0.2	4.4
DCGT11T304MR-SS	L	●			9.525	3.97	0.4	4.4
DCGT11T304ML-SS	L	●			9.525	3.97	0.4	4.4

2/2

\* Nominal value (Max.)



# DCGT

## 7° POSITIVE INSERTS (WITH HOLE)



G Class

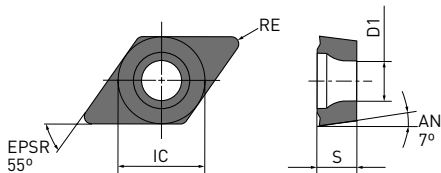
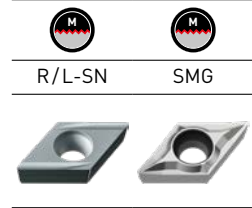

Order number		MS6015	MS7025	MS9025	IC	S	RE*	D1
DCGT070201MR-SN	M	●	●	●	6.35	2.38	0.1	2.8
DCGT070201ML-SN	M	●	★	★	6.35	2.38	0.1	2.8
DCGT070202MR-SN	M	●	●	●	6.35	2.38	0.2	2.8
DCGT070202ML-SN	M	●	★	★	6.35	2.38	0.2	2.8
DCGT070204MR-SN	M	●	●	●	6.35	2.38	0.4	2.8
DCGT11T301MR-SN	M	●	●	●	9.525	3.97	0.1	4.4
DCGT11T301ML-SN	M	●	★	★	9.525	3.97	0.1	4.4
DCGT11T302MR-SN	M	●	●	●	9.525	3.97	0.2	4.4
DCGT11T302ML-SN	M	●	★	★	9.525	3.97	0.2	4.4
DCGT11T304MR-SN	M	●	●	●	9.525	3.97	0.4	4.4
DCGT11T304ML-SN	M	●	★	★	9.525	3.97	0.4	4.4
DCGT070201M-SMG	M	●			6.35	2.38	0.1	2.8
DCGT070202M-SMG	M	●			6.35	2.38	0.2	2.8
DCGT070204M-SMG	M	●			6.35	2.38	0.4	2.8
DCGT11T301M-SMG	M	●			9.525	3.97	0.1	4.4
DCGT11T302M-SMG	M	●			9.525	3.97	0.2	4.4
DCGT11T304M-SMG	M	●			9.525	3.97	0.4	4.4

1/1

\* Nominal value (Max.)



# TCGT / VCET / VCGT

## 7° POSITIVE INSERTS (WITH HOLE)

**P** **M** **S**

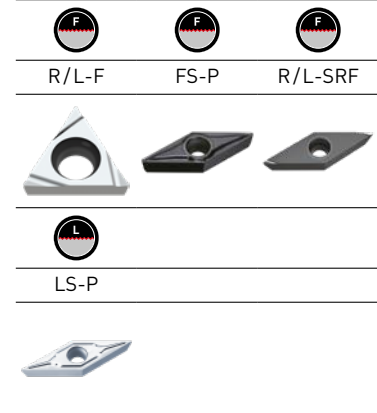
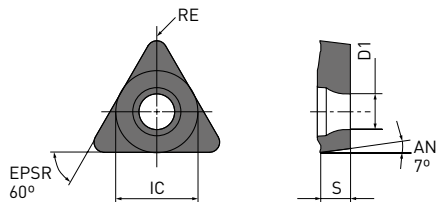

**E, G Class**

**TCGT**

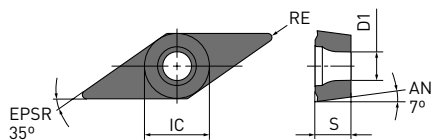

**VCET/VCET**



Order number	 	MS6015	MS7025	MS9025	IC	S	RE*	D1
TCGT060101MR-F	F	●			3.97	1.59	0.1	2.3
TCGT060101ML-F	F	●			3.97	1.59	0.1	2.3
TCGT060102MR-F	F	●			3.97	1.59	0.2	2.3
TCGT060102ML-F	F	●			3.97	1.59	0.2	2.3
TCGT060104MR-F	F	●			3.97	1.59	0.4	2.3
TCGT060104ML-F	F	●			3.97	1.59	0.4	2.3
VCGT110301M-FS-P	F		●	●	6.35	3.18	0.1	2.8
VCGT110302M-FS-P	F		●	●	6.35	3.18	0.2	2.8
VCGT110304M-FS-P	F			●	6.35	3.18	0.4	2.8
<b>NEW</b> VCET080202MR-SRF	F			●	4.76	2.38	0.2	2.4
<b>NEW</b> VCET080202ML-SRF	F			●	4.76	2.38	0.2	2.4
<b>NEW</b> VCET080204MR-SRF	F			●	4.76	2.38	0.4	2.4
<b>NEW</b> VCET080204ML-SRF	F			●	4.76	2.38	0.4	2.4
<b>NEW</b> VCET110301MR-SRF	F			●	6.35	3.18	0.1	2.8
<b>NEW</b> VCET110301ML-SRF	F			●	6.35	3.18	0.1	2.8
<b>NEW</b> VCET110302MR-SRF	F			●	6.35	3.18	0.2	2.8
<b>NEW</b> VCET110302ML-SRF	F			●	6.35	3.18	0.2	2.8
<b>NEW</b> VCET110304MR-SRF	F			●	6.35	3.18	0.4	2.8
<b>NEW</b> VCET110304ML-SRF	F			●	6.35	3.18	0.4	2.8
VCGT110301M-LS-P	L		●	●	6.35	3.18	0.1	2.8
VCGT110302M-LS-P	L		●	●	6.35	3.18	0.2	2.8
VCGT110304M-LS-P	L		●	●	6.35	3.18	0.4	2.8
VCGT130301M-LS-P	L			●	7.94	3.18	0.1	3.4
VCGT130302M-LS-P	L			●	7.94	3.18	0.2	3.4
VCGT130304M-LS-P	L			●	7.94	3.18	0.4	3.4

1/1

\* Nominal value (Max.)

● = Expansion

● : Inventory maintained. ★ : Inventory maintained in Japan.

# VPET / VPGT

## 11° POSITIVE INSERTS (WITH HOLE)

P M S

E, G Class

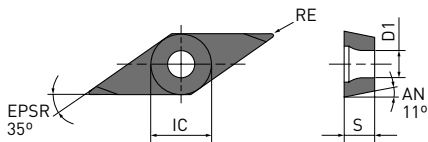

Order number		MS6015	MS7025	MS9025	IC	S	RE	D1
VPGT080201M-FS-P	F			●	4.76	2.38	0.1 <sup>*1</sup>	2.42
VPGT080202M-FS-P	F			●	4.76	2.38	0.2 <sup>*1</sup>	2.42
VPGT110301M-FS-P	F			●	6.35	3.18	0.1 <sup>*1</sup>	2.85
VPGT110302M-FS-P	F			●	6.35	3.18	0.2 <sup>*1</sup>	2.85
<b>NEW</b> VPET1103V3R-SRF	F			●	6.35	3.18	0.03 <sup>*2</sup>	2.85
<b>NEW</b> VPET1103V3L-SRF	F			●	6.35	3.18	0.03 <sup>*2</sup>	2.85
<b>NEW</b> VPET080201MR-SRF	F			●	4.76	2.38	0.1 <sup>*1</sup>	2.42
<b>NEW</b> VPET080201ML-SRF	F			●	4.76	2.38	0.1 <sup>*1</sup>	2.42
<b>NEW</b> VPET080202MR-SRF	F			●	4.76	2.38	0.2 <sup>*1</sup>	2.42
<b>NEW</b> VPET080202ML-SRF	F			●	4.76	2.38	0.2 <sup>*1</sup>	2.42
<b>NEW</b> VPET110301MR-SRF	F			●	6.35	3.18	0.1 <sup>*1</sup>	2.85
<b>NEW</b> VPET110301ML-SRF	F			●	6.35	3.18	0.1 <sup>*1</sup>	2.85
<b>NEW</b> VPET110302MR-SRF	F			●	6.35	3.18	0.2 <sup>*1</sup>	2.85
<b>NEW</b> VPET110302ML-SRF	F			●	6.35	3.18	0.2 <sup>*1</sup>	2.85

1/1

\*1 Nominal value (Max.)



\*2 Nominal value (Med.)







# MS6015 / MS7025 / MS9025

## RECOMMENDED CUTTING CONDITIONS

Material	Properties	Conditions			Grade		Vc	f	ap
			F	L					
Pure iron Free cutting steel	—	●	F	MS6015	R/L-FS	150 ( 50 – 200)	0.01 – 0.15	0.1 – 0.5	
		●	F	MS6015	R/L-F	150 ( 50 – 200)	0.01 – 0.15	0.1 – 0.5	
		●	L	MS6015	LS-P	150 ( 50 – 200)	0.01 – 0.15	0.3 – 3.0	
		●	L	MS6015	R/L-SS	150 ( 50 – 200)	0.01 – 0.15	0.2 – 1.0	
		●	M	MS6015	R/L-SN	150 ( 50 – 200)	0.01 – 0.15	0.1 – 0.5	
		●	M	MS6015	SMG	150 ( 50 – 200)	0.01 – 0.15	0.1 – 2.0	
Soft magnetic iron	—	●	F	MS6015	R/L-FS	200 (150 – 250)	0.01 – 0.15	0.1 – 0.5	
		●	F	MS7025	FS-P	200 (100 – 300)	0.01 – 0.06	0.2 – 0.7	
		●	F	MS6015	R/L-F	200 (150 – 250)	0.01 – 0.15	0.1 – 0.5	
		●	F	MS7025	R-SRF	200 (100 – 300)	0.01 – 0.06	0.1 – 0.5	
		●	L	MS6015	LS-P	200 (150 – 250)	0.01 – 0.15	0.1 – 0.5	
		●	L	MS7025	LS-P	200 (100 – 300)	0.01 – 0.06	0.1 – 0.5	
		●	L	MS6015	R/L-SS	200 (150 – 250)	0.01 – 0.15	0.2 – 1.0	
		●	M	MS6015	R/L-SN	200 (150 – 250)	0.01 – 0.15	0.1 – 0.5	
Carbon and alloy steel	180 – 280 HB	●	F	MS6015	R/L-FS	100 ( 50 – 150)	0.01 – 0.15	0.1 – 0.5	
		●	F	MS7025	FS-P	90 ( 40 – 130)	0.01 – 0.06	0.2 – 0.7	
		●	F	MS6015	R/L-F	100 ( 50 – 150)	0.01 – 0.15	0.1 – 0.5	
		●	L	MS6015	LS-P	100 ( 50 – 150)	0.01 – 0.15	0.3 – 3.0	
		●	L	MS7025	LS-P	90 ( 40 – 130)	0.01 – 0.06	0.3 – 3.0	
		●	L	MS6015	R/L-SS	100 ( 50 – 150)	0.01 – 0.15	0.2 – 1.0	
		●	M	MS6015	R/L-SN	100 ( 50 – 150)	0.01 – 0.15	0.1 – 0.5	
		●	M	MS7025	R/L-SN	90 ( 40 – 130)	0.01 – 0.06	0.1 – 0.5	
Austenitic stainless steel	—	●	F	MS7025	FS-P	60 ( 40 – 100)	0.01 – 0.08	0.2 – 0.7	
		●	F	MS9025	FS-P	100 ( 60 – 150)	0.04 – 0.15	0.2 – 0.7	
		●	F	MS7025	R-SRF	60 ( 40 – 100)	0.01 – 0.08	0.1 – 0.5	
		●	F	MS9025	R/L-SRF	100 ( 60 – 150)	0.04 – 0.15	0.1 – 0.5	
		●	L	MS7025	LS-P	60 ( 40 – 100)	0.01 – 0.08	0.3 – 3.0	
		●	L	MS9025	LS-P	100 ( 60 – 150)	0.05 – 0.15	0.3 – 3.0	
		●	M	MS7025	R-SN	60 ( 40 – 100)	0.01 – 0.08	0.1 – 5.0	
		●	M	MS9025	R-SN	100 ( 60 – 150)	0.05 – 0.15	0.1 – 5.0	
Ferritic and martensitic stainless steel	—	●	F	MS7025	FS-P	60 ( 40 – 100)	0.01 – 0.08	0.2 – 0.7	
		●	F	MS7025	R-SRF	60 ( 40 – 100)	0.01 – 0.08	0.1 – 0.5	
		●	L	MS7025	LS-P	60 ( 40 – 100)	0.01 – 0.08	0.3 – 3.0	
		●	M	MS7025	R/L-SN	60 ( 40 – 100)	0.01 – 0.08	0.1 – 5.0	
Electromagnetic stainless steel (DIN X105CrMo17, DIN X30Cr13 etc.)	Hardness 230 HBW	●	F	MS9025	FS-P	100 ( 50 – 180)	0.04 – 0.12	0.2 – 1.8	
		●	F	MS7025	FS-P	80 ( 40 – 160)	0.02 – 0.08	0.2 – 1.8	
		●	F	MS9025	R/L-SRF	100 ( 50 – 180)	0.04 – 0.12	0.1 – 0.5	
		●	F	MS7025	R-SRF	80 ( 40 – 160)	0.03 – 0.08	0.1 – 0.5	
		●	L	MS9025	LS-P	100 ( 50 – 180)	0.04 – 0.15	0.3 – 3.0	
		●	L	MS7025	LS-P	80 ( 40 – 160)	0.02 – 0.10	0.3 – 3.0	
		●	M	MS9025	R-SN	100 ( 50 – 180)	0.01 – 0.10	0.1 – 5.0	
		●	M	MS7025	R-SN	80 ( 40 – 160)	0.01 – 0.10	0.1 – 5.0	

## MS6015/MS7025/MS9025

Material	Properties	Conditions				Grade		Vc	f	ap
			F	L	M					
M Precipitation hardening stainless steel (DIN X5CrNiCuNb16-4, DIN X7CrNiAl17-7 etc.)	<450 HB	●	F	MS7025	FS-P	60 (40 – 80)	0.01 – 0.10	0.1 – 1.4		
		●	F	MS9025	FS-P	70 (50 – 100)	0.03 – 0.15	0.1 – 1.4		
		●	F	MS7025	R-SRF	60 (40 – 80)	0.01 – 0.10	0.1 – 0.5		
		●	F	MS9025	R/L-SRF	70 (50 – 100)	0.03 – 0.15	0.1 – 0.5		
		●	L	MS7025	LS-P	60 (40 – 80)	0.04 – 0.10	0.2 – 3.0		
		●	L	MS9025	LS-P	70 (50 – 100)	0.04 – 0.15	0.2 – 3.0		
		●	M	MS7025	R-SN	60 (40 – 80)	0.03 – 0.10	0.3 – 3.0		
		●	M	MS9025	R-SN	70 (50 – 100)	0.04 – 0.15	0.3 – 3.0		
S Heat resistant alloy (SUH etc.)	—	●	F	MS9025	FS-P	80 (40 – 140)	0.04 – 0.12	0.2 – 1.4		
		●	F	MS9025	R/L-SRF	80 (40 – 140)	0.05 – 0.12	0.1 – 0.5		
		●	L	MS9025	LS-P	80 (40 – 140)	0.04 – 0.15	0.3 – 3.0		
		●	M	MS9025	R-SN	80 (40 – 140)	0.01 – 0.10	0.1 – 5.0		

2/2

# BTAH

## EXTERNAL BACK TURNING

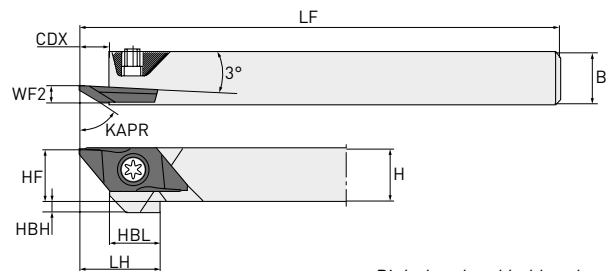
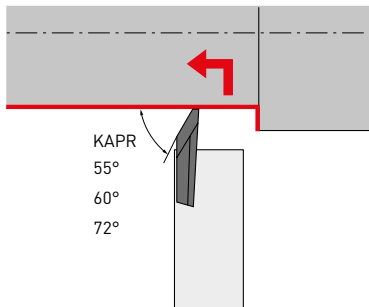

Right hand tool holder shown.

Order number	Stock		Insert type	H	B	LF	LH	HF	WF2	HBH	HBL	CDX		
	R	L												
BTAHR/L0810-50	●	★	BTAT	8	10	120	15	8	3.5	4	9.5	5.5	NS402W	NKY15S
BTAHR/L1010-50	●	★		10	10	120	15	10	3.5	2	9.5	5.5	NS402W	NKY15S
BTAHR/L1212-50	●	★		12	12	120	15	12	3.5	—	9.5	5.5	NS403W	NKY15S
BTAHR1616-50	●			16	16	120	15	16	3.5	—	9.5	5.5	NS403W	NKY15S

1/1

\* Clamp torque (N • m) : NS402W=1.0, NS403W=1.0

1. Please use right hand insert for right hand holder and left hand insert for left hand holder.
2. Set the maximum depth of cut under 60 % of the effective cutting edge length (LE).

## INSERTS

Order number	Hand	VP15TF	MS6015	PSIRR / L	Geometry						
					REL	CF	L	W1	CW	S	LE*
<b>WITH BREAKER</b>											
BTAT7235V5R-SMB	R	●	72°	0.05	0.3	20	8	1.4	2.5	3.5	
BTAT723501MR-SMB	R	●	72°	0.08	0.3	20	8	1.4	2.5	3.5	
BTAT723502MR-SMB	R	●	72°	0.18	0.3	20	8	1.4	2.5	3.5	
BTAT552800R-B	R	●	55°	0	0	20	8	0.5	2.5	2.8	
BTAT552800L-B	L	★	55°	0	0	20	8	0.5	2.5	2.8	
BTAT552801R-B	R	●	55°	0.1	0	20	8	0.5	2.5	2.8	
BTAT552801L-B	L	★	55°	0.1	0	20	8	0.5	2.5	2.8	
BTAT603500R-B	R	●	60°	0	0	20	8	0.5	2.5	3.5	
BTAT603500L-B	L	★	60°	0	0	20	8	0.5	2.5	3.5	
BTAT603501MR-B	R	●	60°	0.08	0	20	8	0.5	2.5	3.5	
BTAT603501R-B	R	●	60°	0.1	0	20	8	0.5	2.5	3.5	
BTAT603501L-B	L	★	60°	0.1	0	20	8	0.5	2.5	3.5	
<b>WITHOUT BREAKER</b>											
BTAT605000RX	R	●	60°	0	0	20	8	1.25	2.5	5.0	

Right hand insert shown.

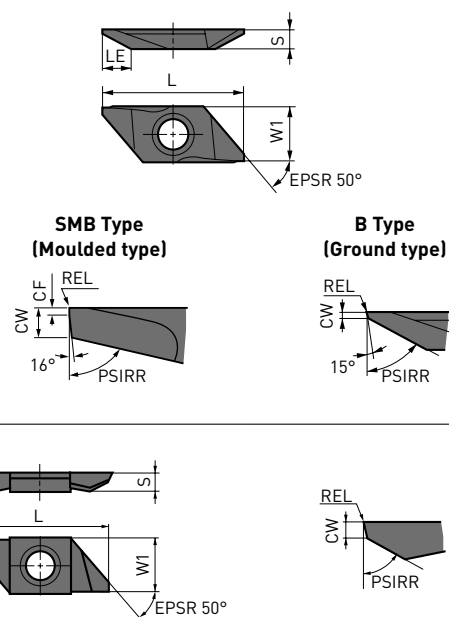

1/1

(5 inserts in one case)



\* Value with insert on the holder.

# CTBH

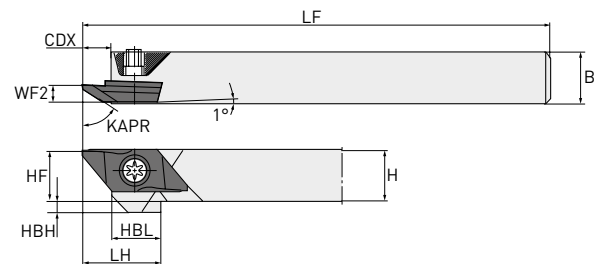
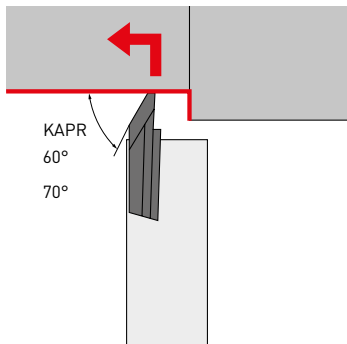
## EXTERNAL BACK TURNING



Right hand tool holder shown.

Order number	Stock		Insert type	H	B	LF	LH	HF	WF2	HBH	HBL	CDX	 Clamp screw	 Wrench
	R	L												
CTBHR/L1010-160	●	●		10	10	120	19.5	10	3.4	2	12	7.5	NS402W	NKY15S
CTBHR/L1212-160	●	●	BTBT 	12	12	120	19.5	12	3.4	—	12	7.5	NS403W	NKY15S
CTBHR/L1616-160	●	●		16	16	120	19.5	16	3.4	—	12	7.5	NS403W	NKY15S

1/1

\* Clamp torque (N • m): NS402W = 1.0, NS403W = 1.0

1. Please use right hand insert for right hand holder and left hand insert for left hand holder.
2. Set the maximum depth of cut under 60 % of the effective cutting edge length (LE).

## INSERTS

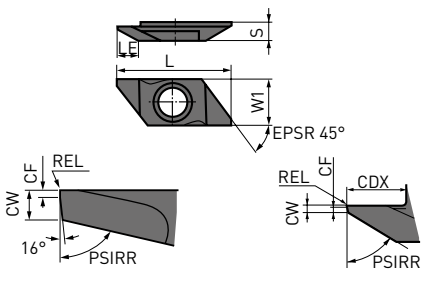
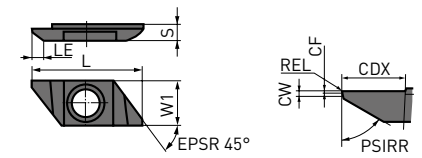
Order number	Hand	VP15TF	MS6015	PSIRR/L	REL	CF	L	W1	CW	S	CDX	LE*1	Geometry	
													EPSR 45°	PSIRR
<b>WITH BREAKER</b>														
BTBT7055V5R-SMB	R	●	70°	0.05	0.3	25	9.4	1.35	3.5	6.5	5.5			
BTBT705501MR-SMB	R	●	70°	0.08	0.3	25	9.4	1.35	3.5	6.5	5.5			
BTBT705502MR-SMB	R	●	70°	0.18	0.3	25	9.4	1.35	3.5	6.5	5.5			
BTBT604500R-B	R	●	60°	0	0.2	25	9.4	0.7	3.5	5.5	4.5			
BTBT604500L-B	L	★	60°	0	0.2	25	9.4	0.7	3.5	5.5	4.5			
BTBT604501MR-B	R	●	60°	0.08	0.3	25	9.4	0.7	3.5	5.5	4.5			
BTBT604501R-B	R	●	60°	0.1	0.3	25	9.4	0.7	3.5	5.5	4.5			
BTBT604501L-B	L	★	60°	0.1	0.3	25	9.4	0.7	3.5	5.5	4.5			
<b>WITHOUT BREAKER</b>														
BTBT606000R	R	●	60°	0	0.2	25	9.4	0.7	3.5	7	6.0			
BTBT606000L	L	★	60°	0	0.2	25	9.4	0.7	3.5	7	6.0			

1/1

(5 inserts in one case)

- \*1 Value with insert on the holder.  
 2. SMB type (Moulded)  
 3. B type (Ground)



# BTAH / CTBH

## RECOMMENDED CUTTING CONDITIONS

	Material	Hardness	Grade	Vc	f
P	Carbon steel, Alloy steel	180 HB – 280 HB	MS6015/VP15TF	100 (50 – 150)	0.08 (0.01 – 0.15)
	Free cutting steel	–	MS6015	110 (30 – 180)	0.08 (0.01 – 0.15)
M	Stainless steel	<200 HB	VP15TF	80 (50 – 120)	0.06 (0.02 – 0.1 )
N	Non-ferrous metal	–	MS6015	150 (70 – 230)	0.09 (0.03 – 0.15)

1/1





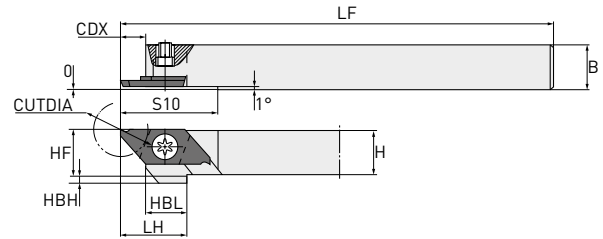
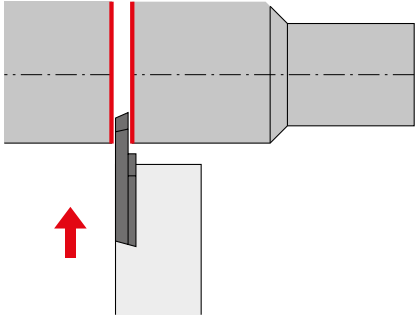

# CTAH

## EXTERNAL CUTTING OFF



Right hand tool holder shown.

Order number	Stock		Insert type	H	B	HF	LF	LH	CDX	HBH	HBL	S10	CUTDIA <sup>*1</sup>	 <sup>*3</sup>			
	R	L															
CTAHR/L0810-120	●	●	CTAT 	8	10	8	120	15	5.5	4	9.5	22	12 (8) <sup>*2</sup>	 <sup>*3</sup>			
CTAHR/L1010-120	●	●		10	10	10	120	15	5.5	2	9.5	22				NS402W	NKY15S
CTAHR/L1212-120	●	●		12	12	12	120	15	5.5	—	9.5	22				NS403W	NKY15S
CTAHR/L1616-120	●	●		16	16	16	120	15	5.5	—	9.5	22				NS403W	NKY15S

1/1

<sup>\*1</sup> CUTDIA: Max. cut off diameter

<sup>\*2</sup> When the parting off width (CW) is 0.7 mm.



<sup>\*3</sup> Clamp torque (N • m): NS401 = 3.5

# CTAH-S

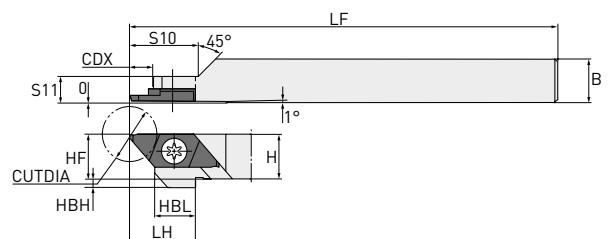
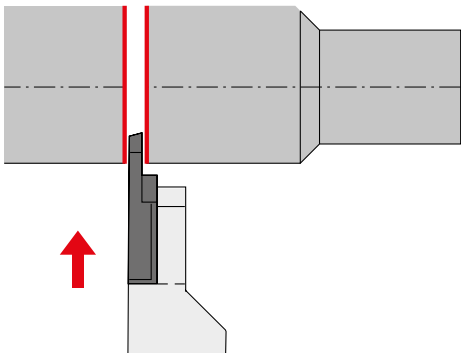
## EXTERNAL CUTTING OFF



Right hand tool holder shown.

Order number	Stock		Insert type	H	B	HF	LF	LH	CDX	HBH	HBL	S10	S11	CUTDIA <sup>*1</sup>	 <sup>*3</sup>	
	R	L														
CTAHR1010-120S	●		CTAT 	10	10	10	80	15	16	2	9.5	16	5.5	12 (8) <sup>*2</sup>	NS401	NKY25R

1/1

<sup>\*1</sup> CUTDIA: Max. cut off diameter

<sup>\*2</sup> When the parting off width (CW) is 0.7 mm.

<sup>\*3</sup> Clamp torque (N • m): NS401 = 3.5

● : Inventory maintained. ★ : Inventory maintained in Japan.



# INSERTS

Order number	Hand	VP15TF	MS6015	CW	CDX	RER/L	L	W1	S	LBB	CUTDIA*	Set geometry	Insert geometry	Geometry
														Right hand insert shown.
<b>WITH BREAKER</b>														
CTAT07080V5RR-B	R	●		0.7	4.5	0.05	20	8	2.5	1.5	8			
CTAT10120V5RR-B	R	●	●	1.0	6.7	0.05	20	8	2.5	1.5	12			
CTAT15120V5RR-B	R	●	●	1.5	6.7	0.05	20	8	2.5	1.5	12			
CTAT20120V5RR-B	R	●	●	2.0	6.7	0.05	20	8	2.5	1.5	12			
CTAT15120V5RR-BX	R	●		1.5	6.7	0.05	20	8	2.5	1.5	12			
CTAT20120V5RR-BX	R	●		2.0	6.7	0.05	20	8	2.5	1.5	12			
<b>WITHOUT BREAKER</b>														
CTAT10120V5RN-B	N	●	●	1.0	6.7	0.05	20	8	2.5	1.5	12			
CTAT15120V5RN-B	N	●	●	1.5	6.7	0.05	20	8	2.5	1.5	12			
CTAT20120V5RN-B	N	●	●	2.0	6.7	0.05	20	8	2.5	1.5	12			
CTAT15120V5RN-BX	N	●		1.5	6.7	0.05	20	8	2.5	1.5	12			
CTAT20120V5RN-BX	N	●		2.0	6.7	0.05	20	8	2.5	1.5	12			
CTAT10110V5RL-B	L	●		1.0	6.7	0.05	20	8	2.5	1.5	11			
CTAT15110V5RL-B	L	●		1.5	6.7	0.05	20	8	2.5	1.5	11			
CTAT20110V5RL-B	L	●		2.0	6.7	0.05	20	8	2.5	1.5	11			
<b>WITHOUT BREAKER</b>														
CTAT1012000RR	R	●	●	1.0	6.7	0	20	8	2.5	3.5	12			
CTAT1512000RR	R	●	●	1.5	6.7	0	20	8	2.5	3.5	12			
CTAT2012000RR	R	●	●	2.0	6.7	0	20	8	2.5	3.5	12			
<b>WITH BREAKER</b>														
CTAT07080V5LL-B	L	●		0.7	4.5	0.05	20	8	2.5	1.5	8			
CTAT10120V5LL-B	L	●		1.0	6.7	0	20	8	2.5	1.5	12			
CTAT15120V5LL-B	L	●		1.5	6.7	0	20	8	2.5	1.5	12			
CTAT20120V5LL-B	L	●		2.0	6.7	0	20	8	2.5	1.5	12			
CTAT10120V5LN-B	N	●	●	1.0	6.7	0.05	20	8	2.5	1.5	12			
CTAT15120V5LN-B	N	●	●	1.5	6.7	0.05	20	8	2.5	1.5	12			
CTAT20120V5LN-B	N	●	●	2.0	6.7	0.05	20	8	2.5	1.5	12			
CTAT10110V5LR-B	R	●	●	1.0	6.7	0.05	20	8	2.5	1.5	11			
CTAT15110V5LR-B	R	●	●	1.5	6.7	0.05	20	8	2.5	1.5	11			
CTAT20110V5LR-B	R	●	●	2.0	6.7	0.05	20	8	2.5	1.5	11			
<b>WITHOUT BREAKER</b>														
CTAT1012000LL	L	●		1.0	6.7	0	20	8	2.5	3.5	12			
CTAT1512000LL	L	●		1.5	6.7	0	20	8	2.5	3.5	12			
CTAT2012000LL	L	●		2.0	6.7	0	20	8	2.5	3.5	12			

(5 inserts in one case)

\* CUTDIA: Max. cut off diameter

# CTBH

## EXTERNAL CUTTING OFF

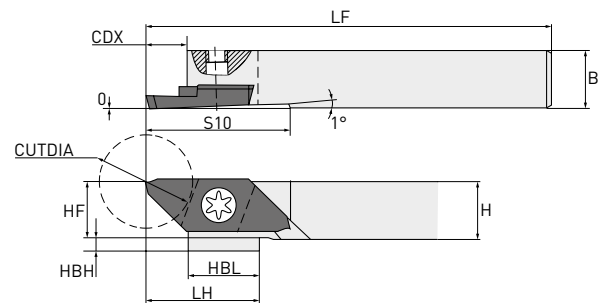
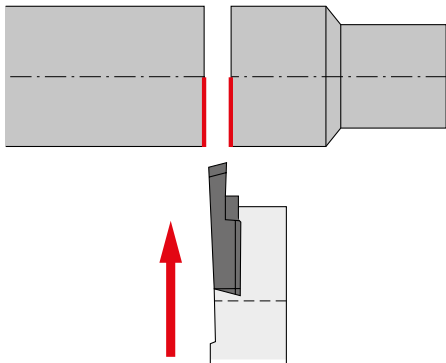

Right hand tool holder shown.

Order number	Stock		Insert type	H	B	HF	LF	LH	CDX	HBH	HBL	S10	CUTDIA* <sup>1</sup>	* <sup>2</sup>	
	R	L												Clamp screw	Wrench
CTBHR/L1010-160	●	●		10	10	10	120	19.5	7.5	2	9.5	25	16	NS402W	NKY15S
CTBHR/L1212-160	●	●	CTBT ○○○○	12	12	12	120	19.5	7.5	—	9.5	25	16	NS403W	NKY15S
CTBHR/L1616-160	●	●		16	16	16	120	19.5	7.5	—	9.5	25	16	NS403W	NKY15S

1/1

\*<sup>1</sup> CUTDIA: Max. cut off diameter

\*<sup>2</sup> Clamp torque (N • m): NS402W = 1.0, NS403W = 1.0

## INSERTS

Order number	Hand	VP15TF	MS6015	CW	CDX	RER/L	L	W1	S	CUTDIA*	Set geometry	Insert geometry	Geometry
													Right hand insert shown.
<b>WITH BREAKER</b>													
CTBT15160V5RR-B	R	●	●	1.5	9.2	0.05	25	9.4	3.5	16			
CTBT20160V5RR-B	R	●	●	2.0	9.2	0.05	25	9.4	3.5	16			
CTBT20160V5RN-B	N	●	●	2.0	9.2	0.05	25	9.4	3.5	16			
CTBT20160V5LL-B	L	●		2.0	9.2	0.05	25	9.4	3.5	16			
CTBT20160V5LN-B	N	●	●	2.0	9.2	0.05	25	9.4	3.5	16			
CTBT20145V5LR-B	R	●	●	2.0	9.2	0.05	25	9.4	3.5	14.5			

1/1

(5 inserts in one case)

\* CUTDIA: Max. cut off diameter

● : Inventory maintained. ★ : Inventory maintained in Japan.

# CTAH / CTAH-S / CTBH

## RECOMMENDED CUTTING CONDITIONS

	Material	Hardness	Grade	Vc	f
P	Carbon steels, Alloy steels	180 HB – 280 HB	MS6015/VP15TF	100 (50 – 150)	0.05 (0.02 – 0.09)
	Free cutting steels	—	MS6015	110 (30 – 180)	0.05 (0.01 – 0.09)
M	Stainless steels	<200 HB	VP15TF	80 (50 – 120)	0.03 (0.02 – 0.05)
N	Non-ferrous metals	—	MS6015	150 (70 – 230)	0.07 (0.03 – 0.11)

1/1



# MS9025

## CUTTING PERFORMANCE

### STAINLESS STEEL X105CRM017 (DIN 1.4125), WEAR RESISTANCE COMPARISON

Workpiece material	X105CrMo17 (DIN 1.4125)
Insert	DCGT11T302
Vc (m/min)	100
f (mm/rev)	0.08
ap (mm)	1.0
Cutting mode	External Continuous cutting Wet cutting (Oil)

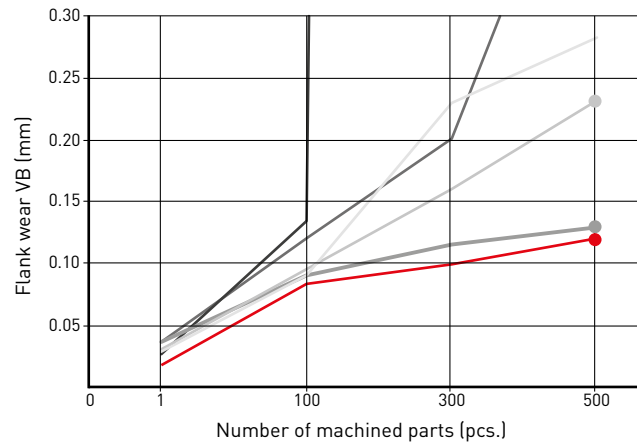

### After machining 500 parts



MS9025

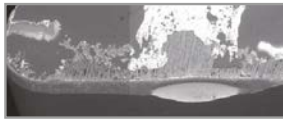

Conventional D:  
Base material exposed



Conventional C:  
Peeling of the coating

# MS7025

## APPLICATION EXAMPLES

Workpiece material	X105CrMo17 (DIN 1.4125)
Insert	DCGT070202M-FS-P (MS7025)
Component	Valve
Application	External and face, continuous turning
Vc (m/min)	58
f (mm/rev)	0.04
ap (mm)	0.15
Cutting mode	Wet cutting (Oil)
Result	Compared to conventional products, the dimensional accuracy is stable and a high machining quality is maintained.

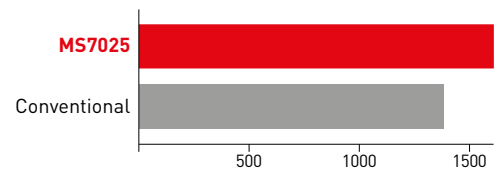
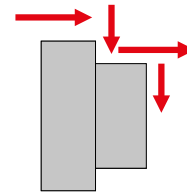

Workpiece material	X14CrMoS17 (DIN1.4104)
Insert	DCGT11T302M-FS-P (MS7025)
Component	Shaft Parts
Application	External and face, continuous turning
Vc (m/min)	130
f (mm/rev)	0.03
ap (mm)	0.56
Cutting mode	Wet cutting (Oil)
Result	Chip control has been improved and the quality of the machined surface is also excellent.

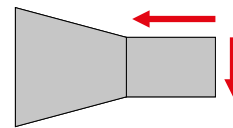

Workpiece material	X6Cr17 (DIN1.4016)
Insert	DCGT11T302M-FS-P (MS7025)
Component	Machine parts
Application	External and face, continuous turning
Vc (m/min)	100
f (mm/rev)	0.06
ap (mm)	0.25
Cutting mode	Wet cutting (Oil)
Result	By suppressing chip welding, cutting edge damage is reduced and the surface quality can be improved.

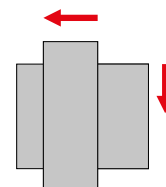

The application examples above are from customers workpieces and can therefore differ from the recommended cutting conditions.

# MS9025

## APPLICATION EXAMPLES

Workpiece material	X30Cr13 (DIN1.4028) Stainless steel
Insert	DCGT11T302M-LS-P
Component	Solenoid parts
Application	External continuous turning
Vc (m/min)	117
f (mm/rev)	0.1
ap (mm)	0.2
Cutting mode	Wet cutting (Oil)
Result	Improved wear resistance and tool life increased by a factor of 1.7.

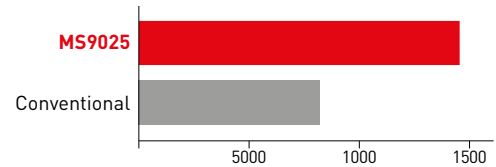
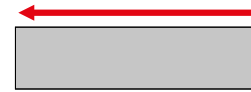

Workpiece material	X105CrMo17 (DIN 1.4125) Electromagnetic stainless steel
Insert	DCGT070201M-FS-P
Component	Brake parts
Application	External continuous turning
Vc (m/min)	38
f (mm/rev)	0.05
ap (mm)	0.2
Cutting mode	Wet cutting (Oil)
Result	Improved welding resistance and double tool life when compared to a conventional tool.

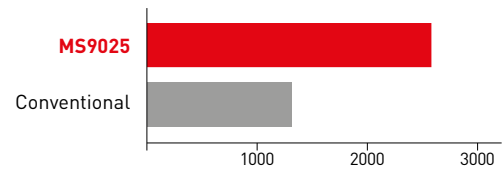
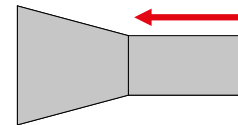

Workpiece material	X40CrSi-Mo10-2 Heat resistant alloy
Insert	DCGT11T304M-LS-P
Component	Valve
Application	External and face, continuous turning
Vc (m/min)	80
f (mm/rev)	0.12 – 0.15
ap (mm)	0.3 – 0.5
Cutting mode	Wet cutting (Oil)
Result	Conventional products tend to produce a worsening surface finish during processing. However, the machined surface with MS9025 is stable even when the tool life is 5 times more.

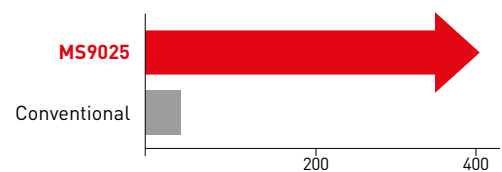
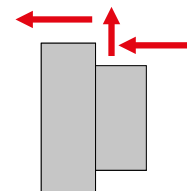

The application examples above are from customers workpieces and can therefore differ from the recommended cutting conditions.



# MS6015

## APPLICATION EXAMPLES

Insert	DCGT11T302M-SMG (MS6015)
Workpiece material	Pure iron (JIS SUr)
Cutting mode	External, continuous
Vc (m/min)	197 (4500 min <sup>-1</sup> )
f (mm/rev)	0.1
ap (mm)	0.1
Coolant	Wet cutting (oil)
Result	Number of workpieces: 500

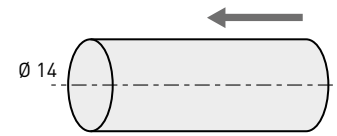
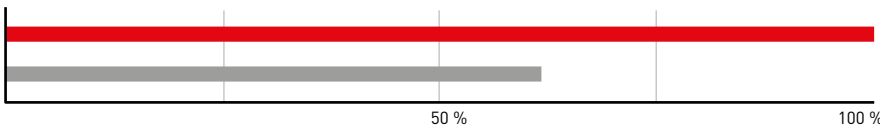

An excellent finished surface and 1.4 x longer tool life compared with conventional products. Stability and good chip discharge management with the SMG breaker.

Insert	DCGT11T301MR-SN (MS6015)
Workpiece material	Free cutting steels (11SMnPb30 (DIN 1.0718))
Cutting mode	External, continuous
Vc (m/min)	125 (5000 min <sup>-1</sup> )
f (mm/rev)	0.05
ap (mm)	0.3
Coolant	Wet cutting (oil)
Result	Number of workpieces: 3000

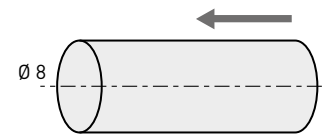
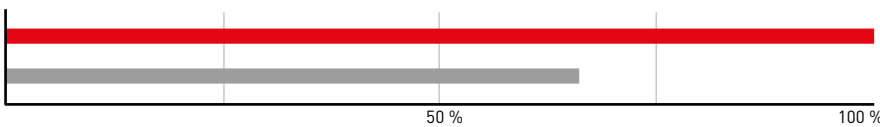

MS6015 shows minimal chip welding and maintains dimensional accuracy.

Insert	DCGT11T302MR-SN (MS6015)
Workpiece material	Carbon steel (DIN CK45)
Cutting mode	External, continuous
Vc (m/min)	113 (3000 min <sup>-1</sup> )
f (mm/rev)	0.03
ap (mm)	1.0
Coolant	Wet cutting (oil)
Result	Number of workpieces: 1100

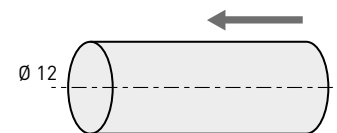
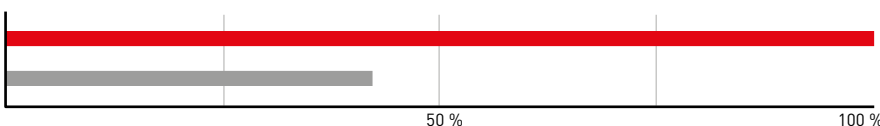

MS6015 has superior wear resistance and achieves 2 x longer tool life compared to conventional products.

Insert	DCGT11T302M-SMG (MS6015)
Workpiece material	Mild steel (DIN CK15)
Cutting mode	External, continuous
Vc (m/min)	100 (1300 min <sup>-1</sup> )
f (mm/rev)	0.12
ap (mm)	1.3
Coolant	Wet cutting (oil)
Result	Number of workpieces: 500

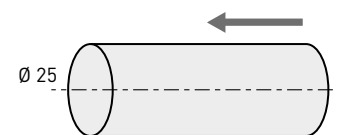
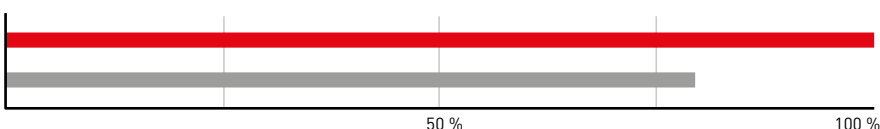

MS6015 has superior welding resistance and achieves 1.3 x longer tool life compared to conventional products.



## EUROPEAN SALES COMPANIES

### GERMANY

MMC HARTMETALL GMBH  
Comeniusstr. 2 . 40670 Meerbusch  
Phone +49 2159 91890 . Fax +49 2159 918966  
Email admin@mmchg.de

### U.K. Office

MMC HARDMETAL U.K. LTD.  
Mitsubishi House . Galena Close . Tamworth . Staffs. B77 4AS  
Phone +44 1827 312312  
Email sales@mitsubishicarbide.co.uk

### SPAIN

MITSUBISHI MATERIALS ESPAÑA, S.A.  
Calle Emperador 2 . 46136 Museros/Valencia  
Phone +34 96 1441711  
Email comercial@mmevalencia.es

### FRANCE

MMC METAL FRANCE S.A.R.L.  
6, Rue Jacques Monod . 91400 Orsay  
Phone +33 1 69 35 53 53 . Fax +33 1 69 35 53 50  
Email mmfsales@mmc-metal-france.fr

### POLAND

MMC HARDMETAL POLAND SP. Z O.O  
Al. Armii Krajowej 61 . 50-541 Wrocław  
Phone +48 71335 1620 . Fax +48 71335 1621  
Email sales@mitsubishicarbide.com.pl

### ITALY

MMC ITALIA S.R.L.  
Viale Certosa 144 . 20156 Milano  
Phone +39 0293 77031 . Fax +39 0293 589093  
Email info@mmc-italia.it

### TURKEY

MMC HARTMETALL GMBH ALMANYA - İZMİR MERKEZ ŞUBESİ  
Adalet Mahallesi Anadolu Caddesi No: 41-1 . 15001 35530 Bayraklı / İzmir  
Phone +90 232 5015000 . Fax +90 232 5015007  
Email info@mmchg.com.tr

[www.mmc-carbide.com](http://www.mmc-carbide.com)

DISTRIBUTED BY:

□

□

┌

└

B275E 

Published by: MMC Hartmetall GmbH – A Sales Company of  MITSUBISHI MATERIALS | 2024.10